



Operating Instructions

**Vacuum Clamping Chuck
VAC-MAT™**





Doc-ID: Witt-7444

Before starting all tasks, read the operating instructions!



© Horst Witte Gerätebau
Barskamp e.K.
Horndorfer Weg 26-28
D-21354 Bleckede (Germany)

Tel.: +49 / 58 54 / 89-0
Fax: +49 / 58 54 / 89-40

E-mail: info@horst-witte.de
Website: www.horst-witte.de

Release:
Prepared by:
Kothes!
Technische Kommunikation GmbH & Co. KG
www.kothes.de



Contents

- 1 General6**
 - 1.1 Information to these instructions6
 - 1.2 Other applicable documents6
 - 1.3 Symbol explanation.....7
 - 1.4 Liability Limitation.....8
 - 1.5 Copyright protection8
 - 1.6 Warranty conditions9
 - 1.7 After-sales service.....10
- 2 Safety11**
 - 2.1 Responsibility of the operating company11
 - 2.2 Personnel Requirements12
 - 2.2.1 Qualifications12
 - 2.2.2 Unauthorized persons.....12
 - 2.3 Personal Protective Equipment.....13
 - 2.4 Intended use14
 - 2.5 Special Hazards15
- 3 Technical Data18**
 - 3.1 Dimension sheet18
- 4 Design and Function.....19**
 - 4.1 Brief description19
 - 4.2 Overview19
 - 4.3 Description of Assemblies.....20
 - 4.4 Scope of delivery.....20
- 5 Transportation, Packaging and Storage21**
 - 5.1 Safety instructions for transportation21
 - 5.2 Transportation inspection.....21
 - 5.3 Packaging21
 - 5.4 Storage.....22
- 6 Installation and Commissioning23**
 - 6.1 Safety23
 - 6.2 Installation24
 - 6.3 Coupling vacuum clamping chucks.....24
 - 6.4 Clamping the workpiece.....26
 - 6.5 Tasks after use.....28



7	Repair	29
7.1	Servicing	29
7.2	Malfunction Table	29
8	Accessories and Spare Parts	30
8.1	Stop washers	30
8.2	VAC-MATs™	31
8.3	Other	32
9	Index	33



General

1 General

1.1 Information to these instructions

These instructions facilitate the safe and efficient handling of the equipment.

The instructions are part of the equipment and must be kept in the direct vicinity of the equipment, accessible for the personnel at all times. Before starting any tasks, personnel must carefully read and understand these instructions. Prerequisite for safe working is the compliance with all specified safety and handling instructions in these instructions.

Furthermore, the local statutory accident prevention and general safety regulations for the operating area of the equipment apply.

Figures in these instructions are for the fundamental understanding and can deviate from the actual construction of the equipment.

1.2 Other applicable documents

The clamping chuck must be connected to a vacuum pump.

In addition to these instructions, also refer to the documentation of the vacuum pump used for the clamping chuck.

1.3 Symbol explanation

Safety Instructions

In these instructions, safety instructions are designated by symbols. The safety instructions are initiated by key words that express the extent of the hazard.

To prevent accidents, injury to persons and damage to property, comply implicitly with the safety instructions and be careful.



WARNING!

... indicates a possible hazardous situation that can lead to death, or to severe injuries, if they are not prevented.



CAUTION!

... indicates a possible hazardous situation that can lead to lesser or lighter injuries, if they are not prevented.



CAUTION!

... indicates a possible hazardous situation that can lead to damage of property, if they are not prevented.

Tips and recommendations



NOTE!

... accentuates useful tips and recommendations, as well as information for efficient and fault-free operation.



General

1.4 Liability Limitation

All data and notes in these instructions were prepared with consideration to the statutory standards and regulations, the present state of technology, as well as our many years of knowledge and experience.

The manufacturer accepts no liability for damage caused because of:

- Non-compliance with the instructions
- Non-specified use
- Use of untrained personnel
- Arbitrary modification
- Technical changes
- Use of uncertified spare parts

The actual scope of delivery can, by special designs, deviate from the explanations and presentations given here, because of the utilization of additional order options, or because of the most recent technical changes.

The responsibilities agreed in the delivery contract, the General Terms and Conditions as well as the delivery conditions of the manufacturer and the statutory regulations valid at the time of the conclusion of the contract are effective.

We reserve the right to make technical changes in the framework of improvement of the handling features and further development.

1.5 Copyright protection

These instructions are copyright protected and are determined exclusively for internal purposes.

Except for internal use, relinquishment of the instructions to a third party, duplication in any type or form – also extracts – as well as exploitation and/or communication of the contents is not permitted without the written authority of the manufacturer.

Contravention commits to compensation. Rights reserved for further demands.

1.6 Warranty conditions

Guarantee

- The company must immediately reprehend all forms of deficiencies and claims. Apparent defects must be notified in writing within a period of two weeks from receipt of the goods. Punctual dispatch suffices to comply with the time limit. The company takes full liability for proof for all claims, especially for the deficiency itself, for the time of identifying the defect and for the punctual notification of the defect. The notice of defect is to be effected by quoting the contract or invoice number. Non-apparent defects must be notified within two weeks of detection, in accordance with the aforementioned explanations.
- If there is a defect, the company WITTE has the right to select the warranty afforded, namely a choice of supplying a spare part or by rectification. The company WITTE is authorized to refuse the remedy requested by the company, if it is only possible with disproportionate costs and the other type of remedy has no remaining substantial disadvantages for the company.
- The warranty demands can no longer be invoked after the expiry of one year after delivery of the goods. Fundamentally, only the product description is decisive and agreed for the quality of the goods. Public announcements, promotions or advertising, in addition to non-contractual statements, do not represent the quality of the goods.
- In the case of a legal deficiency or material defect, after unsuccessful rectification, the company only has the right to withdraw from the contract. In addition, there is no claim for indemnity through the defect.

Severability clause

Should individual conditions of the contract with the company be, or become, invalid in whole or in part, including these General Terms and Conditions, the effectivity of the remaining conditions is not prejudiced herewith. The whole, or partly invalid settlement, should be replaced by a settlement, whose commercial success is as near as possible to the invalid one. Verbal agreements are not valid, if they are not agreed retrospectively or in writing.



General

Liability exclusion

- The company WITTE accepts no liability for facile, negligent breaches of responsibility, provided that it is not concerned with essential contractual obligations (cardinal obligations), independent of whether the company WITTE, or a vicarious agent, perpetrates a breach of obligation. The company WITTE accepts no liability for fundamental culpable blame, as a non-managerial vicarious agent. By moderate negligence of breaches of responsibility, the liability is limited to the typical damage occurring in transactions of the contractual type.
- The aforementioned liability limitations are not applicable to demands of the company regarding product liability. Furthermore, the liability limitations are not valid for bodily and health injuries attributable to us, or by loss of life of the contractor or his vicarious agent.
- Any claim for indemnity by the contractor for a defect becomes invalid after one year from the delivery of the goods. This is not valid if the company WITTE is reproached for malice.

1.7 After-sales service

For technical advice, our after-sales service is available. Contact data, refer to Page 2.

Furthermore, our staff are continually interested in new information and experiences that comes from the application and could be useful for improving our products.

2 Safety

This section gives an overview of all important safety aspects for optimum protection of the personnel, as well as for the safe and fault-free operation.

The non-compliance of the handling and safety instructions given in these instructions can lead to serious hazards.

2.1 Responsibility of the operating company

The equipment is used in the industrial field. Thus, the operating company of the equipment is subject to the statutory obligations for occupational health and safety.

Additional to the occupational health and safety instructions in these operating instructions, the accident prevention and environmental protection regulations for the field of operation must also be adhered to. Thereby, it is especially imperative that:

- The operating company must inform itself about the effective industrial regulations and determine additional hazards in a risk assessment that result through the special working conditions at the place of operation of the equipment. The company must implement these in the form of operating instructions for the operation of the equipment.
- During the total operating time of the equipment, the operating company must check to make sure that the established operating instructions conform to the current status of the rules and standards and, as necessary, adapt them.
- The operating company must make sure that all staff who handle the equipment have read the operating instructions and understood them.
Furthermore, the personnel must be instructed at regular intervals and informed about the dangers.
- The operating company must provide the required safety equipment for the personnel.



Safety

2.2 Personnel Requirements

2.2.1 Qualifications



WARNING!

Danger of injury if the skills are insufficient!

Incorrect handling can lead to substantial injuries to persons and damage to property.

Therefore:

- All tasks must be carried out by personnel qualified for the tasks.

In the operating instructions, the qualification for the different fields of activity are given as follows.

■ **Instructed person**

was instructed by the operating company in a briefing about the tasks assigned to them and instructed about possible hazards because of improper conduct.

■ **Specialists**

because of the technical training, knowledge and experience and also awareness of the relevant regulations, are in the position to carry out the tasks assigned to them and be able to autonomously identify and prevent possible hazards.

Only persons who can be expected to carry out their tasks reliably are authorized. Persons whose responsiveness is affected, e.g. by drugs, alcohol or medicines are not authorized.

- When selecting the operating personnel, make sure to observe all age and occupational regulations applicable at the place of installation.

2.2.2 Unauthorized persons



WARNING!

Danger to unauthorized persons!

Unauthorized persons are those who do not fulfil the requirements described here, do not know the hazards in the area of operation.

Therefore:

- Keep unauthorized persons clear of the area of operation.
- If in doubt, address the persons and banish them from the area of operation.
- Interrupt the tasks as long as the unauthorized person is in the area of operation.

2.3 Personal Protective Equipment

When working, it is necessary to wear personal protective equipment in order to reduce the health dangers.

- When working, the protective equipment required for the respective task must always be worn.
- Obey the instructions attached in the work area for the personal protective equipment.

Fundamental workwear

For all tasks, fundamentally wear:



Protective clothing

is close fitting workwear with a low tear strength, with tight sleeves and no protruding parts. They predominantly serve to protect from catching in moving machine parts.

Do not wear rings, chains or other jewellery.



Safety shoes

for the protection against heavy parts falling down and from slipping on slippery surface.



Protective gloves

to protect the hands from rubbing, abrasions, cuts or more profound injuries, as well as when touching hot surfaces.



Safety glasses

to protect the eyes from flying parts and splashing liquid.



Safety

2.4 Intended use

The chuck is exclusively conceived and designed for the intended use as described here.

The vacuum clamping chuck serves to clamp and fix flat workpieces with an enclosed surface, so that they can be mechanically machined or measured.



WARNING!

Danger by inappropriate use!

Every application in excess of the intended use and/or other use of the chuck, can lead to hazardous situations.

Therefore:

- Only use the chuck for its intended use.
- It is imperative to adhere to all information in these operating instructions.
- No clamping of workpieces beyond the specification (e.g. wood or finely structured material).

Claims in all form are excluded by inappropriate use.

The operating company is liable for all damage caused by inappropriate use.

2.5 Special Hazards

In the following section, remaining risks are specified that were determined during a risk evaluation.

- In order to reduce danger to health and prevent hazardous situations, observe the safety instructions given here and the warning notices in the further chapters in these instructions.

Pneumatics



CAUTION!

Danger of injury from pneumatic power!

Pneumatic power can cause injuries.

Therefore:

- Tasks on the pneumatics must only be carried out by trained specialists.
- Before beginning tasks on the pneumatic system, completely discharge the pressure. Thereby, pay attention to the pressure accumulator.
- Never load the vacuum clamping chuck with a workpiece when operating pressure is present (danger of crushing!).

Sharp edges and corners



CAUTION!

Danger of injury from the edges and corners!

Sharp edges and corners can cause abrasions to and cut the skin.

Therefore:

- Be very careful when carrying out tasks near sharp edges and corners.
- If in doubt, wear protective gloves.



Safety

Contamination and objects laying around



CAUTION!
Danger of tripping on contamination and over objects laying around!

Contamination and objects laying around generate sources of slipping and tripping and can cause substantial injuries.

Therefore:

- Always keep the work area clean.
- Remove objects no longer required.
- Designate tripping positions with yellow-black marker band.

Hot surfaces



CAUTION!
Danger of burning on hot surfaces!

Contact with hot components can cause burns.

Therefore:

- As a matter of principle, for all tasks near hot components, protective clothing and gloves must be worn.
- Before all tasks, make sure that all components have cooled down to the ambient temperature.

Aerosols



WARNING!
Toxic hazard through air contamination!

Increased temperature development can lead to fumigation on the VAC-MAT™, that can cause severe toxication.

Therefore:

- Observe the safety data sheets and manufacturer's instructions, as well as the local statutory regulations.
- Measure air pollution at the workplace on a regular basis at short time intervals.
- If aerosol parts are detected in the ambient air, immediately stop all tasks, vacate the polluted area and sufficiently ventilate the workplaces.
- As necessary, take suitable safety measures on site (e.g. discharging the exhaust air out of the work area and the installation of filter systems in the exhaust system).

Fire hazard and flame development**WARNING!****Fire hazard and flame development!**

Increased temperature development can lead to fusion and ignition of the VAC-MAT™.

Therefore:

- Keep a fire extinguisher ready in the vicinity.
- Immediately report suspicious materials, liquids or gases to the responsible person.
- Do not smoke in the danger zones and immediate surroundings. Refrain from contact with open flames or sources of ignition.
- In case of fire, immediately stop all work. Evacuate the danger zone until the all-clear is given.
- Wear personal protective equipment.

Technical Data

3 Technical Data

Order No.	Designation	L x W x H [mm]	e [mm]	f [mm]	Weight
81759	VAC-MAT™ Starter set single	300 x 200 x 30	80	160	5
82837	VAC-MAT™ Starter set double	300 x 400 x 30	240	400	10
82825	VAC-MAT™ Starter set quadruple	600 x 400 x 30	160	240	20

3.1 Dimension sheet

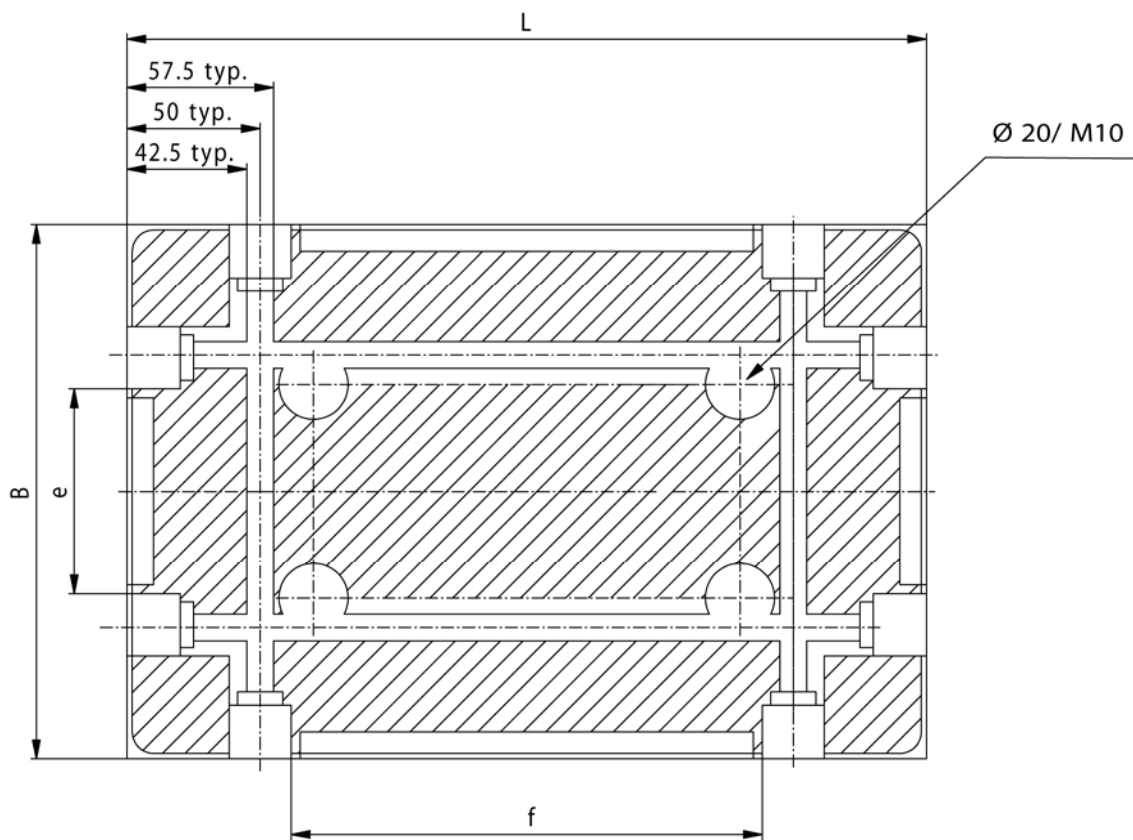

Fig. 1: Dimensions; drilling may be done in the shaded areas

4 Design and Function

4.1 Brief description

The vacuum clamping chuck consists of the aluminium plate and a thin and soft VAC-MAT™ mat.

The vacuum chuck is attached to a machine table and a vacuum pump.

The workpiece positioned on the VAC-MAT™ is clamped by an operating vacuum, so that it can be subsequently machined from 5 sides.

Modular vacuum chucks can be connected to one another, by using chuck connectors, so that larger workpieces can also be machined.

4.2 Overview

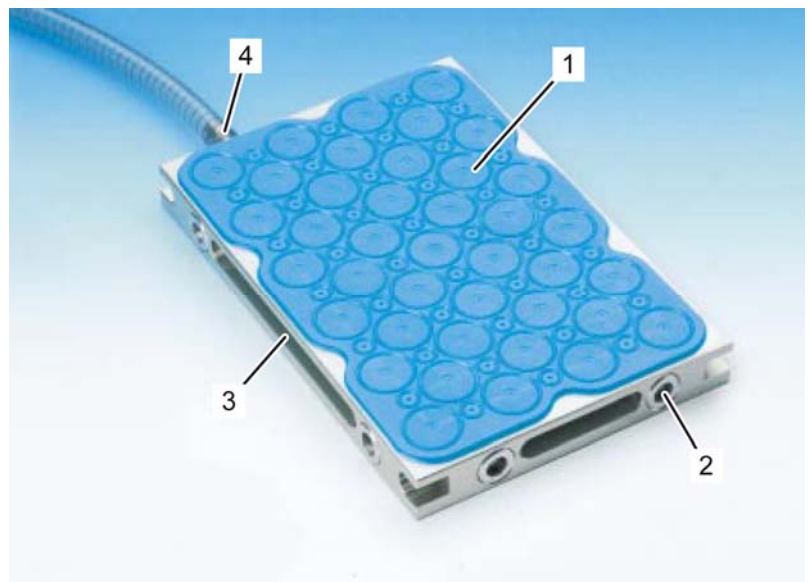

Fig. 2: Overview

- | | | | |
|---|--|---|------------------|
| 1 | VAC-MAT™ mat | 3 | Clamping groove |
| 2 | Blanking plugs (connection for further plates) | 4 | Vacuum connector |

Design and Function

4.3 Description of Assemblies



Fig.3. VAC-MAT™ Clamping Plate

The VAC-MAT™ chuck has 6 positioning recesses on the surface (Fig.3/1) to mount the VAC-MAT™ mat.

One of the recesses is drilled (Fig.3/2) and used to achieve the operating vacuum.

There are two blanking plugs (Fig.3/3) on each side of the VAC-MAT™ clamping plate. At this position, an arbitrary number of VAC-MAT™ clamping plates can be connected to one another, by using chuck connectors.

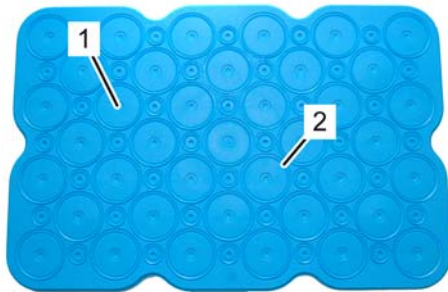

Fig.4. VAC-MAT™ mat

The VAC-MAT™ mat is made from synthetic material and has 77 suction cups of various sizes, with elastic lips (Fig.4/2) on the surface and small vacuum holes (Fig.4/1) in the centre.

On the underside, there are projecting synthetic material lugs for positioning the VAC-MAT™ mat on the VAC-MAT™ chuck.

The service life of the VAC-MAT™ mat is dependent on the number and size of the milled cuts, which result from machining the workpieces.

Using the machining tool, up to 0.25 mm can be milled in the VAC-MAT™ mat.

4.4 Scope of delivery

- 1 x Vacuum clamping chuck
- 1 x Vacuum connector
- 1 x Chuck connector
- 7 x Blanking plugs
- 10 x O-Rings
- 10 x VAC-MAT™ mats (blue)
- 1 x Vacuum hose with wire spiral 18/12 (1 m)
- 1x Tool
- 2 x Clamps (high-tensile aluminium)

5 Transportation, Packaging and Storage

5.1 Safety instructions for transportation

Improper transportation

**CAUTION!****Damage through improper transportation!**

Damage can occur by improper transportation.

Therefore:

- When unloading the packed chuck on delivery, as well as internal transportation, proceed very carefully and obey the symbols and instructions on the packaging.
- Only remove the packaging immediately prior to installation.

5.2 Transportation inspection

Upon receipt of the delivery, immediately check for completeness and for damage during transportation.

In case of obvious external damage through transportation, proceed as follows:

- Do not accept the delivery, or only conditionally.
- Record the scope of the damage on the transport documents of the carrier, or on the delivery note.
- Initiate the reclamation.

**NOTE!**

Reclaim about each defect immediately it is detected. Claims for damage can only be invoked within the statutory reclamation period.

5.3 Packaging

For packaging

The chuck is packed according to the anticipated transportation conditions. Environmentally friendly material is used exclusively for the packaging.

The packaging should protect the chuck and its assemblies from damage during transportation, corrosion and other damage until the installation. Therefore, do not damage the packaging and only remove immediately before installation.



Transportation, Packaging and Storage

Handling the packaging material

Dispose of the packaging material in accordance with the respective statutory regulations and local instructions.



CAUTION!

Environmental damage by incorrect disposal!

Packaging material is valuable raw material and can be used again in many cases, or expediently reprocessed and recycled.

Therefore:

- Dispose packaging material environmentally friendly.
- Observe the local statutory disposal instructions. As necessary, assign a specialized firm for the disposal.

5.4 Storage

Storing the packaging

Store the clamping chuck under the conditions given as follows:

- Do not keep outside.
- Store in the dry and dust-free.
- Do not expose to any aggressive medium.
- Protect from solar radiation.
- Prevent mechanical vibration.
- Storage temperature: 15 to 35 °C.
- Relative humidity: 60 % max.
- For storage of more than 3 months, check the general condition of all components and the packaging. As necessary, renew or replace the conservation.

Store VAC-MAT™ mats under the conditions as follows:

- Only in the original packaging.
- Max. of 4 cartons stacked on one another.
- Storage temperature: max. 25 °C.



NOTE!

Possibly, there are instructions on the packaging for storage that exceed the requirements mentioned here. Conform to these respectively.

6 Installation and Commissioning

6.1 Safety

Improper installation and commissioning



WARNING!

Danger of injury through improper installation and commissioning!

Improper installation and commissioning can cause injury to persons or damage to property.

Therefore:

- Before starting the tasks, make sure that there is sufficient space for installation.
- Be very careful with open components with sharp edges.
- Pay attention to order and cleanliness at the installation site! Loose components and tools on top of one another, or laying around, are sources of accidents.
- All installation tasks should be carried out exclusively by specialists.

Personal Protective Equipment

The protective equipment given as follows must be worn for all installation and commissioning tasks:

- Protective clothing
- Safety shoes
- Protective gloves
- Safety glasses

Installation and Commissioning

6.2 Installation



Fig. 5: Attaching clamps

1. Align the vacuum chuck on the machine table.
2. Attach the vacuum chuck with the clamps on the machine table.



NOTE!

The vacuum chuck can also be directly attached to the machine table.

Thereby, provide the chuck with holes. The dimension sheet in the technical data indicates the positions where holes can be drilled. Hermetically seal the attachment screws at the screw head.

→ **Observe the dimension sheet in the technical data.**



Fig. 6: Connect the vacuum hose

3. Connect the vacuum hose with a 3/2-way valve to the connection adapters on the vacuum chuck.
4. Secure the vacuum hose with a hose clamp.
5. Connect the other end of the vacuum hose to a vacuum unit and a vacuum switch with indicator (Order No. 84886).
→ **Observe the instructions for the vacuum unit.**
6. Arrange the vacuum hose so that no-one can trip over it and, as necessary, designate it with yellow-black marking band.



CAUTION!

Danger through liquids sucked in!

Liquids (e.g. coolant) sucked in during the machining of the workpiece and that get between the clamping surface and the workpiece bearing area can damage the vacuum pump and reduce the workpiece coefficient of friction.

Therefore:

- When using liquids during machining, always connect a liquid separator between the vacuum clamping chuck and vacuum pump.
- Check the workpiece to make sure that it sits firmly.

6.3 Coupling vacuum clamping chucks

A further vacuum chuck can be connected to each side of the vacuum chuck.

Installation and Commissioning

It is not necessary for the connected vacuum chuck to have an additional vacuum hose, because the operating vacuum is effective for all vacuum clamping chucks through the connection adapters.



Fig. 7: Release the screws

1. Release the screws on the sides of the vacuum clamping chuck to which further vacuum clamping chucks should be connected.



Fig. 8: Remove the blanking plugs

2. Use the assembly tool and remove the blanking plugs.



Fig. 9: Install the chuck connectors

3. Install the chuck connectors to the stop.

Installation and Commissioning

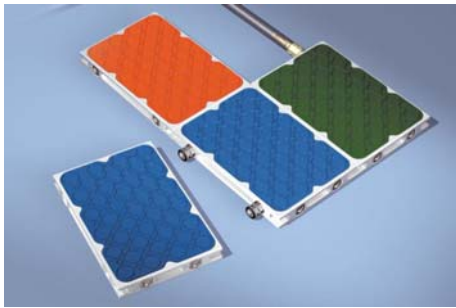

Fig. 10: Connected plates

4. Connect further vacuum clamping chucks.
5. Tighten all screws.

6.4 Clamping the workpiece



CAUTION!

Insufficient retention force between the workpiece and vacuum clamping chuck!

The retaining and traversing forces cannot be compared to those of a vice! Clamped workpieces can loosen themselves from the vacuum clamping chuck and cause injuries and damage to property.

Therefore:

- The operating vacuum must be constant and a minimum of 0.8 to 0.85 bar.
- During the machining of the workpiece, continually check the operating vacuum on a manometer.
- The machining force must always be less than the retaining force.
- By heavier chip removal, always use the stops to secure the workpiece.
- Only use sharp-edged and optimum tools for the material to be machined.
- Especially for small machining surfaces, the machining forces must be kept as low as possible, e.g. by the application of small cutter diameters at high speeds.
- Before machining, check the security of the workpiece.
- A minimum of 50 % of all the suction cups available must be fully covered by the workpiece. Thereby, the position and shape of the workpiece can vary.

Installation and Commissioning



WARNING!

Danger of burns by the hot workpieces and melted VAC-MATs™!

During machining with no coolant, the workpiece can heat up and melt the VAC-MAT™.

Therefore:

- Wear protective gloves and glasses.
- If possible, carry out machining of the workpiece using coolant.
- If melted, hot synthetic material comes into contact with the skin, immediately cool the respective part of the body using ice or water. Do not forcibly remove synthetic material from the skin. Get medical aid.

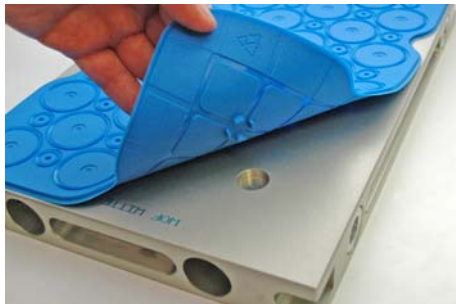

Fig. 11: Mount the VAC-MAT™

1. Place the VAC-MAT™ on the vacuum clamping chuck so that the lugs engage in the recesses in the surface of the plate.
2. Switch on the vacuum pump and open the vacuum valve.
→ **Observe the instructions for the vacuum unit.**
3. Read the pressure on the vacuum indicator.
The pressure must not be less than 82 % vacuum!



NOTE!

Even with no workpiece, a vacuum of more than 80 % can be attained, provided by the small chambers in the VAC-MAT™!

4. Close the vacuum valve.

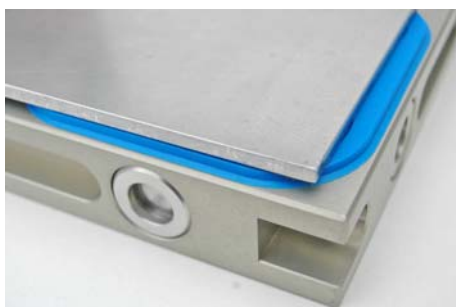

Fig. 12: Clamping the workpiece

5. Position the workpiece on the VAC-MAT™.
Make sure that a min. of 50 % of all available suction cups of the VAC-MAT™ are fully covered by the workpiece. Thereby, the position and shape of the workpiece can vary.
6. Open the vacuum valve and clamp the workpiece.
7. Check the workpiece to make sure that it sits firmly.



NOTE!

Using the machining tool, up to 0.25 mm can be milled in the VAC-MAT™ mat.



Installation and Commissioning

6.5 Tasks after use

1. After machining, before removal of the workpiece, the vacuum clamping chuck must be cleaned with an industrial vacuum system and the operating vacuum.
2. After removing all oddments and swarf, switch off the operating vacuum.
3. Remove the workpiece from the vacuum clamping chuck.



NOTE!

The VAC-MAT™ mats are dedicated for single use. Always replace VAC-MAT™ mats that are damaged or have been milled into and dispose of environmentally friendly.

7 Repair

The possible causes for malfunctions and the tasks for rectification are described in the chapter that follows. For malfunctions that cannot be rectified by the following instructions, contact the manufacturer, refer to the Service Address, Page 2.

7.1 Servicing

The vacuum clamping chuck is maintenance-free. The vacuum clamping chuck must be cleaned at regular intervals and freed from swarf, depending on the requirements, application and degree of contamination. Remove contamination with a cloth or compressed air. No corrosive cleaning agent must be used.

7.2 Malfunction Table

Malfunction	Possible cause	Fault rectification	Rectified by
Operating vacuum is not attained, or is too low and the vacuum pump operates continuously	Leaking vacuum hoses	Replace vacuum hoses	Specialist
	Contamination between the workpiece and vacuum clamping chuck	Clean the material surface and clamping chuck surface	Manufacturer
	Seal defect, or not correctly installed	Replace seal	Specialist
	Kinked vacuum hoses	Correctly adjust the vacuum hoses	Operator
Clamping surface of the vacuum clamping chuck damaged	Machining of the workpiece is inaccurate	Check the machining program	Specialist
Retaining force is insufficient to machine the workpiece	Clamping area is too small	Increase clamping area	Specialist
		Use additional retainers for the workpieces	
	Diameter of the vacuum hoses is too small, or vacuum hoses too long	Increase the diameter of the vacuum hoses, or shorten the vacuum hoses	Specialist
	Insufficient performance of the vacuum pump	Increase the performance of the vacuum pump	Specialist



Accessories and Spare Parts

8 Accessories and Spare Parts



WARNING!

Danger of injuries through incorrect spare parts!

Incorrect or defective spare parts can cause damage, incorrect functioning or complete failure, as well as affecting the safety.

Therefore:

- Only use original manufacturer spare parts.

The spare parts also not quoted in the following table can be obtained directly from Horst Witte Gerätebau. Address, refer to Page 2.

8.1 Stop washers

Number	For plate height [mm]	Set screw/knurled nut	Dimensions [mm]	Order No.
6	32,5	M5	20	85405
9	38,0	M6	27	85409
12	48,0	M6	30	85410

8.2 VAC-MATs™



CAUTION!

Damage to property through incorrect handling and storage!

Incorrect handling can lead to damage of the VAC-MATs™.

Therefore, the VAC-MATs™:

- must not be exposed to aggressive acids, brine and organic cleaning solvents.
- must not be exposed to extended solar or ultraviolet radiation.

Figure	Designation	Dimensions [mm]	Order No.
	VAC-MAT™ blue, standard Range of use, up to max. 40°C	300 x 200 x 2.42	11030
	VAC-MAT™ green, hard Range of use, up to max. 45°C	300 x 200 x 2.42	11053
	VAC-MAT™ red, soft Range of use, up to max. 40°C	300 x 200 x 2.42	11548
	VAC-MAT™ grey Range of use, up to max. 80 °C (by multi-application, only the max. temperature of 50°C is guaranteed)	300 x 200 x 2.42	13156
	VAC-MAT™ black for covering of unoccupied vacuum fields Range of use, up to max. 45°C	300 x 200 x 2.42	11029

The dimensional stability (gauge tolerance) of the VAC-MATs™ is +/- 0.04 mm (measured at the 4 external corners and 2 external edges). The VAC-MAT™ can feature concavity of 0.1 mm, beginning 20 mm circumferentially from the outer area.

Accessories and Spare Parts

8.3 Other

Figure	Designation	Dimensions [mm]	Order No.
	Connection adapters incl. O-ring	Ø1 = 23 Ø2 = 14	81761
	Chuck connectors incl. O-ring	Ø1 = 23	81762
	Blanking plugs incl. O-ring	Ø1 = 23	81774
	O-ring	Ø16 x 2.5	34798
	Assembly tool	Ø16 x 120	28331

9 Index

A		
Accessories	29	
Aerosols	15	
After-sales service	9	
Assemblies	19	
B		
Brief description	18	
Briefing	11	
C		
Clamping the workpiece	25	
Contact person	9	
Contamination	15	
Copyright protection	7	
Coupling vacuum clamping chucks	24	
D		
Design	18	
Dimension sheet	17	
F		
Fire hazard	16	
H		
Hazards	14	
I		
Installation	23	
Intended use	13	
L		
Liability	7	
M		
Malfunction Table	28	
O		
Overview	18	
P		
Packaging	20	
Personnel		
requirements	11	
Pneumatics	14	
Protective equipment	12	
Installation	22	
Protective gloves	12	
Safety glasses	12	
Safety shoes	12	
R		
Repair	28	
S		
Safety		
general	10	
Scope of delivery	19	
Service	9	
Servicing	28	
Spare parts	29	
Specialists	11	
Storage	20, 21	
Surfaces, hot	15	
Symbols		
in the instructions	6	
T		
Technical Data	17	
Transportation	20	
Transportation inspection	20	
W		
Warranty	8	